

uSDR Manual

2021/08/21

Ver:1.1



uSDR is optimized and modified based on the open source work uSDX/QCX-SSB

uSDX/QCX-SSB GitHub:

<https://github.com/threeme3/QCX-SSB/tree/feature-rx-improved>

Introduction:

This is a shortwave QRP SSB/CW transceiver. The ultra-small size is easy to carry to outdoor use, using 1602N LCD screen, built-in speakers! Support to connect to PC and use FT8, JS8, FT4 and other digital mode software control, support CW automatic decoding.

Features:

- + 8 band coverage 80m/60m/40m/30m/20m/17m/15m/10m
- + Excellent PCB layout design in line with high-frequency circuit design principles to ensure excellent performance
- + Can reach 3-5W power in 8 bands and reserve TO-220 package pads required for upgrades
- + High emission efficiency, 80m/60m/40m/30m/20m efficiency is higher than 85%, 17m/15m efficiency is higher than 80%, 10m efficiency is higher than 70%
- + High-precision KDS brand TCXO, frequency accuracy is better than 1PPM, frequency stability is better than 0.5PPM
- + Independent core board and RF board to avoid own signal interference.
- + Ultra-small size: 82.8*28.8*110mm (excluding protruding parts)
- + Rich interfaces (CAT, PTT OUT, MIC/KEY, K-head microphone)
- + All LPF parts use 100V C0G/NP0 capacitors
- + Use original genuine Omron magnetic latching relay
- + Use original genuine LM4562 or LM833 op amp chip
- + Built-in speaker with cavity
- + BNC antenna interface

List of features:

Simple, fun and versatile QRP SSB HF transceiver with embedded DSP and SDR functions;

EER Class-E driven SSB transmit-stage

Approximately 5W PEP SSB output from 13.8V supply

All-Mode support: USB, LSB, CW, AM, FM

DSP filters: 4000, 2500, 1700, 500, 200, 100, 50 Hz passband

DSP features: Automatic Gain Control (AGC), Noise-reduction (NR), Voice-triggered Xmit (VOX), RX Attenuators (ATT), TX noise gate, TX drive control, Volume control, dBm/S-meter.

SSB opposite side-band/carrier suppression Transmit: better than -45dBc, IMD3 (two-tone) -33dBc, Receive: better than -50dBc

Multiband support, continuously tunable through bands 160m-10m (and from 20kHz..99MHz with loss in performance)

Open source firmware, built with Arduino IDE; allows experimentation, new features can be added, contributions can be shared via Github, software-complexity: 2000 lines of code

Software-based VOX that can be used as fast Full Break-In (QSK and semi-QSK operation) or assist in RX/TX switching for operating digital modes (no CAT or PTT interface required), external PTT output/PA control with TX-delay

Simple to install modification with 8 component changes and 8 wires

Lightweight and low-cost transceiver design: because of the EER-transmitter class-E stage it is highly power-efficient (no bulky heatsinks required), and has a simple design (no complex balanced linear power amplifier required)

Fully digital and software-based SSB transmit-stage: samples microphone-input and reconstruct a SSB-signal by controlling the phase of the SI5351 PLL (through tiny frequency changes over 800kbits/s I2C) and the amplitude of the PA (through PWM of the PA key-shaping circuit)

Fully digital and software-based SDR receiver-stages (optionally): samples I/Q (complex) signal from Quadrature Sampling Detector digital mixer, and performs a 90-degree phase-shift mathematically in software (Hilbert-transform) and cancels out one side-band by adding them

Three independent switchable analog front-end receiver attenuators (0dB, -13dB, -20dB, -33dB, -53dB, -60dB, -73dB)

Receiver Noise floor MDS: -135 dBm at 28MHz (in 200Hz BW)

Receiver Front-end selectivity: steep -45dB/decade roll-off +/-2kHz from tuned-frequency

Blocking dynamic range: 20kHz offset 123dB, 2kHz offset 78dB

CW decoder, Straight/Iambic-A/B keyer

VFO A/B + RIT and Split, and corresponding relay band-filter switching via I2C

CAT support (TS480 subset)

Operation:

Currently, the following functions have been assigned to shortcut buttons (L=MENU, E=encoder, R=EXIT) and menu-items:

Menu Item	Function	Button
1.1 Volume	Audio level (0..13) & power-off/on (turn left)	E +turn
1.2 Mode	Modulation (LSB, USB, CW, AM, FM)	R
1.3 Filter BW	Audio passband (Full, 300..3000, 300..2400, 300..1800, 500, 200, 100, 50 Hz), this also controls the SSB TX BW.	R double
1.4 Band	Band-switch to pre-defined CW/FT8 freqs (80,60,40,30,20,17,15,12,10,6m)	E double
1.5 Tuning Rate	Tuning step size 10M, 1M, 0.5M, 100k, 10k, 1k, 0.5k, 100, 10, 1	E or E long
1.6 VFO Mode	Selects different VFO, or RX/TX split-VFO (A, B, Split)	2x R long
1.7 RIT	RX in transit (ON, OFF)	R long
1.8 AGC	Automatic Gain Control (ON, OFF)	
1.9 NR	Noise-reduction level (0-8), load-pass & smooth	
1.10 ATT	Analog Attenuator (0, -13, -20, -33, -40, -53, -60, -73 dB)	
1.11 ATT2	Digital Attenuator in CIC-stage (0-16) in steps of 6dB	
1.12 S-meter	Type of S-Meter (OFF, dBm, S, S-bar)	
2.1 CW Decoder	Enable/disable CW Decoder (ON, OFF)	
2.4 Semi QSK	On TX silents RX on CW sign and word spaces	
2.5 Keyer speed	CW Keyer speed in Paris-WPM (1..35)	
2.6 Keyer mode	Type of keyer (Iambic-A, -B, Straight)	

Menu Item	Function	Button
1.1 Volume	Audio level (0..13) & power-off/on (turn left)	E +turn
2.7 Keyer swap	to swap keyer DIH, DAH inputs (ON, OFF)	
2.8 Practice	to disable TX for practice purposes (ON, OFF)	
3.1 VOX	Voice Operated Xmit (ON, OFF)	
3.2 Noise Gate	Audio threshold for SSB TX and VOX (0-255)	
3.3 TX Drive	Transmit audio gain (0-8) in steps of 6dB, 8=constant amplitude for SSB	
3.4 TX Delay	Delays TX to allow PA relay to be fully switched on before TX (0-255 ms)	
4.1 CQ Interval	Idle time in seconds before new CQ Message is given (0-60)	
4.2 CQ Message	CQ Message text, pressing left-button in menu will start sending	L
8.1 PA Bias min	PA amplitude PWM level (0-255) for representing 0% RF output	
8.2 PA Bias max	PA amplitude PWM level (0-255) for representing 100% RF output	
8.3 Ref freq	Actual si5351 crystal frequency, used for frequency-calibration	
8.4 IQ Phase	RX I/Q phase offset in degrees (0..180 degrees)	
10.1 Backlight	Display backlight (ON, OFF)	
power-up	Reset to factory settings	E long
main	Tune frequency (20kHz..99MHz)	turn
main	Quick menu	L +turn
main	Menu enter	L
RIT	RIT back	R
menu	Menu back	R

Connector definition:



Connector manual

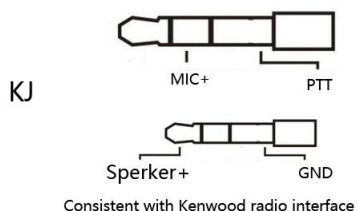
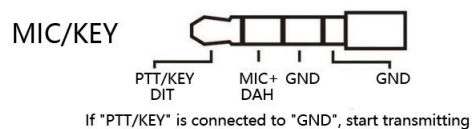
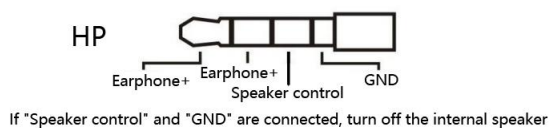
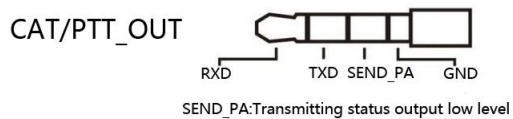

Schematic:

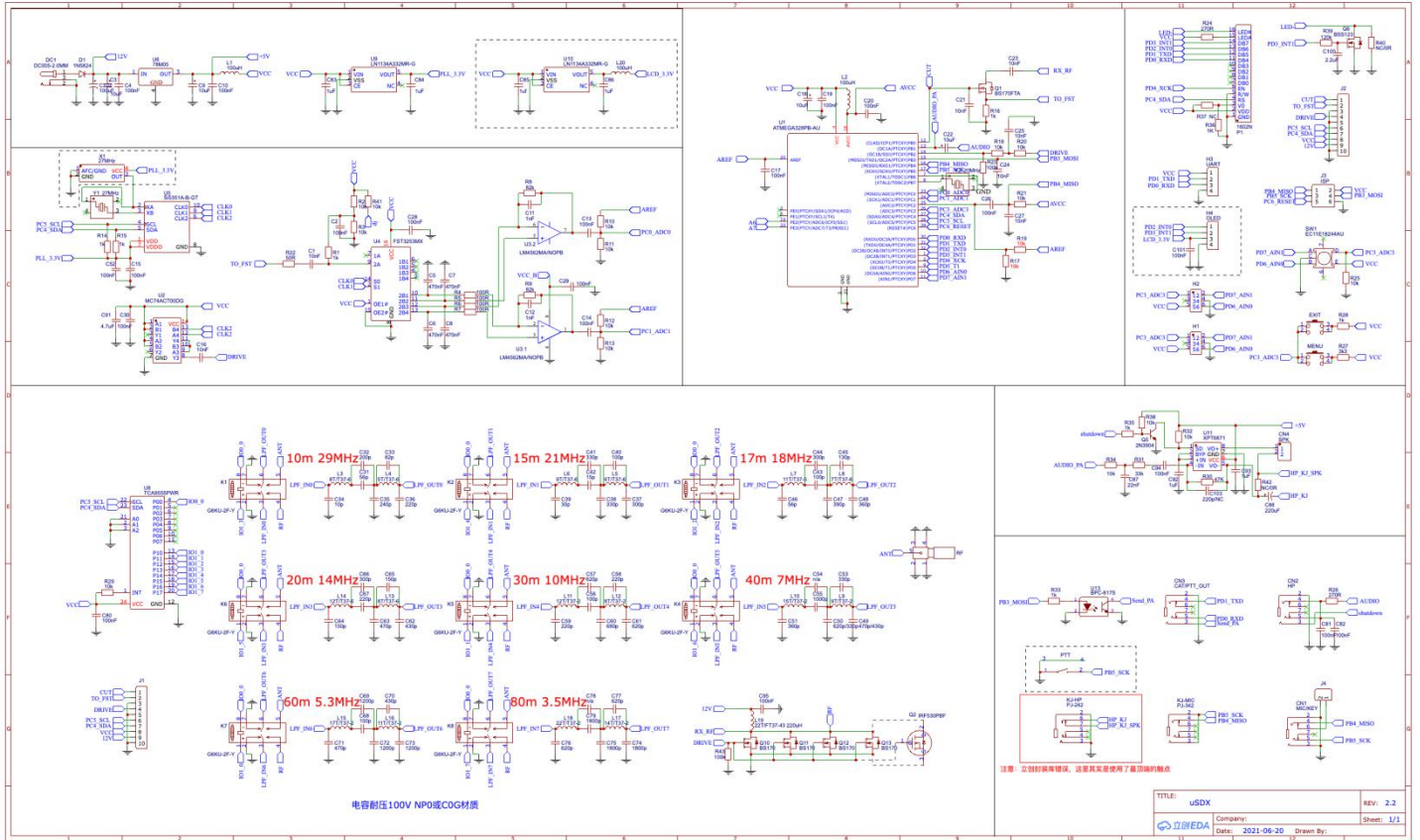

电容耐压100V NP0或COG材质

注意: 立创商城有错误, 这里其实使用了最迟的触点

TITLE:	uSDX	REV:	2.2
Company:	DIBEDA	Sheet:	1/1
Date:	2021-06-20	Drawn By:	

PCB photo:

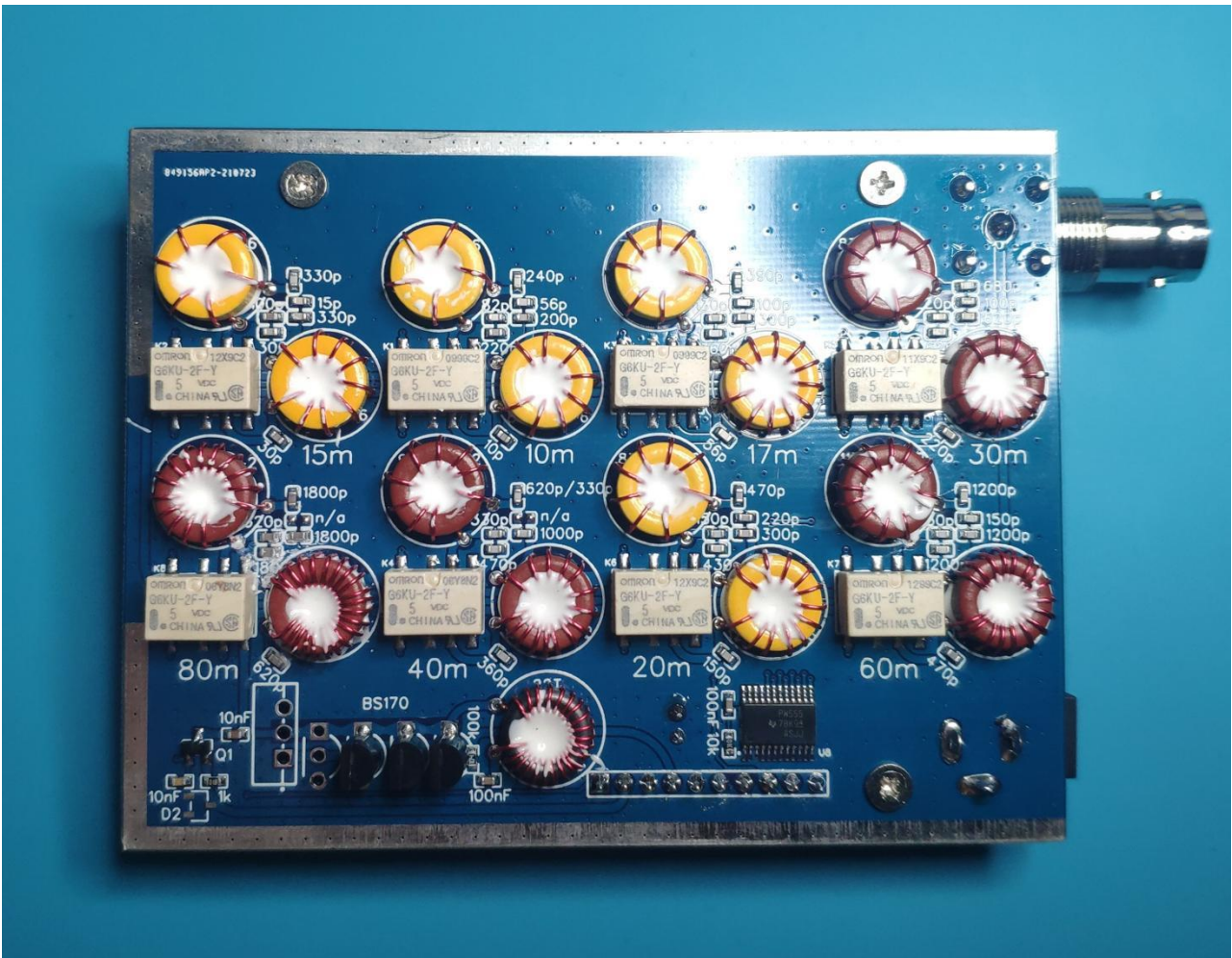
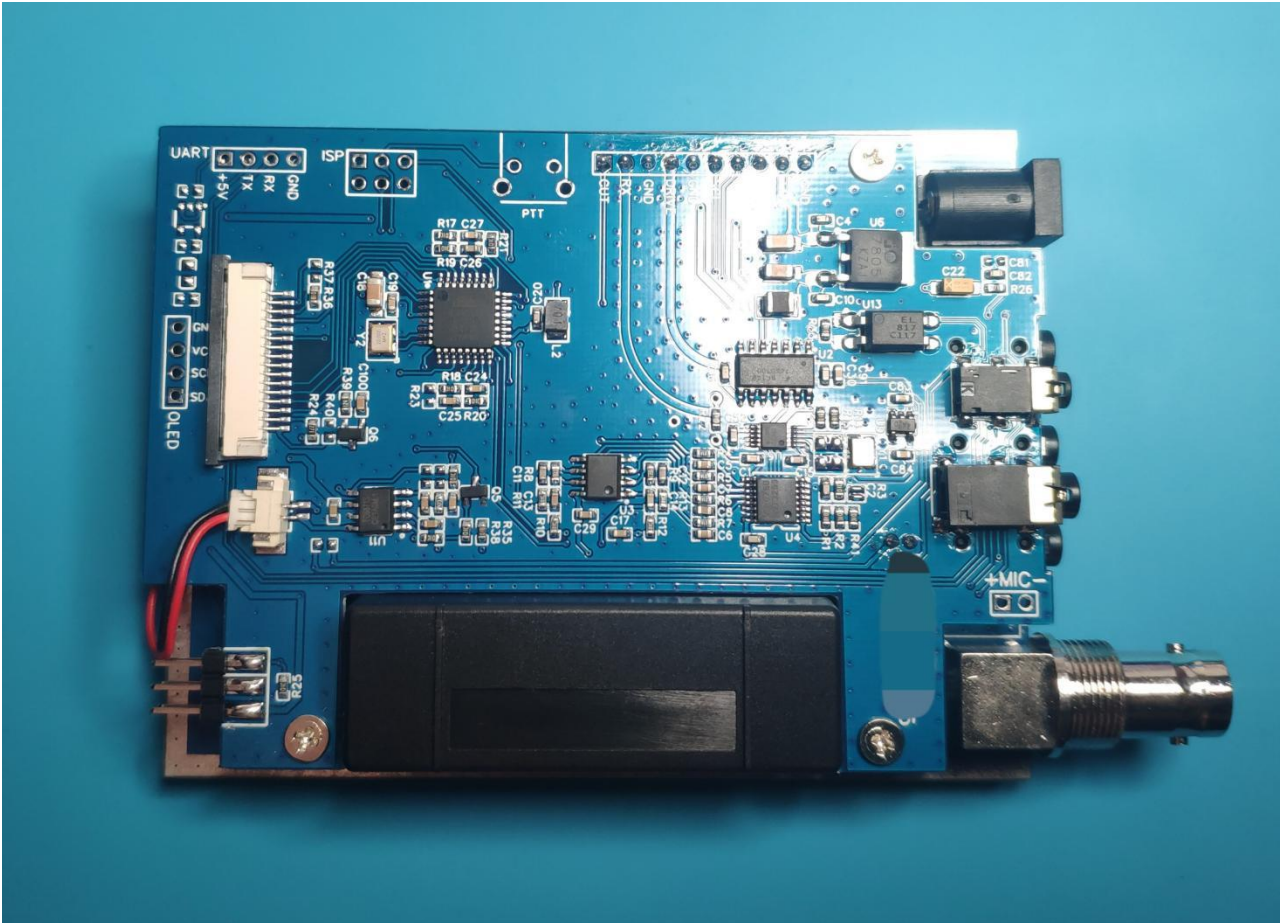

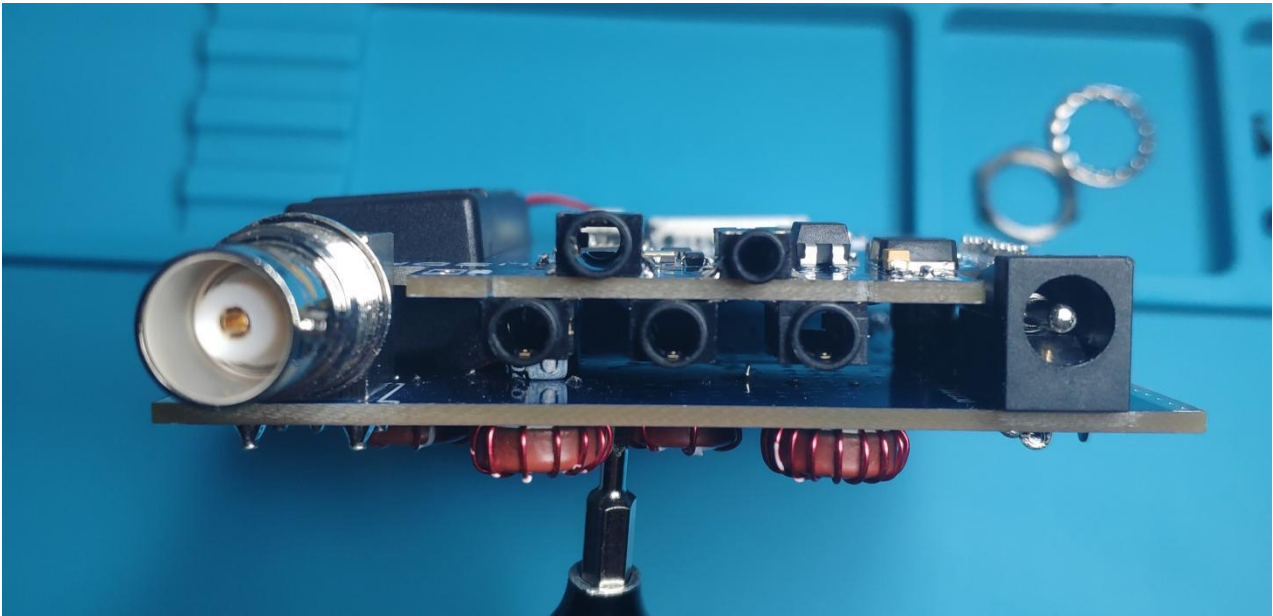

RF efficiency test:

Note: The correct efficiency test should only measure the current consumed by the PA board, not including the current consumption of other components! PA Bias max is not the same for all machines, you need to find the best value based on testing.

frequency	PA Bias max	Voltage	Current(A)	Power consumption(W)	RF power(W)	Efficiency
3.573MHz	162	13.1	0.65	8.515	7.32	0.859659425
5.375MHz	160	13.1	0.58	7.598	6.73	0.88575941
7.074MHz	138	13.1	0.58	7.598	6.76	0.889707818
10.136MHz	135	13.1	0.42	5.502	4.82	0.876045075
14.074MHz	149	13.1	0.44	5.764	5.29	0.917765441
18.100MHz	134	13.1	0.32	4.192	3.53	0.842080153
21.074MHz	161	13.1	0.40	5.24	4.27	0.814885496
28.074MHz	148	13.1	0.46	6.026	4.39	0.728509791

Warning: The hardware version is updated and optimized without notice! ! !

This machine is optimized and modified according to open source settings, and its performance and functions are fully compatible with the original design. You can refer to the following introduction from the open source website.

Introduction to qcx-ssb/usdx (organized from GitHub):

This is a simple and experimental modification that transforms a [QCX](#) into a (Class-E driven) SSB transceiver. It can be used to make QRP SSB contacts, or (in combination with a PC) used for the digital modes such as FT8, JS8, FT4. It can be fully-continuous tuned through bands 80m-10m in the LSB/USB-modes with a 2400Hz bandwidth has up to 5W PEP SSB output and features a software-based full Break-In VOX for fast RX/TX switching in voice and digital operations.

The SSB transmit-stage is implemented entirely in digital and software-based manner: at the heart the ATMEGA328P is sampling the input-audio and reconstructing a SSB-signal by controlling the SI5351 PLL phase (through tiny frequency changes over 800kbit/s I2C) and controlling the PA Power (through PWM on the key-shaping circuit). In this way a highly power-efficient class-E driven SSB-signal can be realized; a PWM driven class-E design keeps the SSB transceiver simple, tiny, cool, power-efficient and low-cost (ie. no need for power-inefficient and complex linear amplifier with bulky heat-sink as often is seen in SSB transceivers).

For the receiver, a large portion of the original QCX circuit has been removed and implemented in digital manner (software): the ATMEGA328P is now implementing the 90 degree phase shift circuit, the (CW/SSB) filter circuit and the audio amplifier circuit (now a class-D amplifier). This has simplified the QCX circuit a lot (50% less components needed), and there are a number of advantages and features: there is no longer a need for an alignment procedure due to the very accurate 90 degree Hilbert phase shifter; and there are now adjustable IF DSP filters for CW and SSB; and there is an AGC and there is a noise-reducing DSP signal conditioning function and there are three indepent built-in attenuators in the analog front-end which helps utilizing the full dynamic range. The speaker is directly connected and driven by the ATMEGA. A digital mixer with narrow low-pass window (2 kHz), steep roll-off (-45dB/decade) combined with an oversampling and decimating ADC are responsible for a processing gain, dynamic range and alias rejection sufficient to handle weak and strong signal conditions (e.g. contests or listening on 40m just next to broadcasting band).

This experiment is created to try out what is can be achieved with minimal hardware while moving complexity towards software; here the approach followed is to simplify the design where possible while keep a reasonable performance. The result is a cheap, easy to build, versatile QRP SSB transceiver that actually is quite suitable for making QSOs (even in contest situations), however due to the experimental nature some parts are still in progress and hence limited. Feel free to try it out or to experiment with this sketch, let me know your thoughts or contribute here: <https://github.com/threeme3/QCX-SSB> The original forum discussion on the topic here: [QRPLabs Forum](#)

Update: A new group with collaborative interest has started to build a compact, portable (SOTA) rig for the summer, based on the ideas presented here. More information can be found in this: [Forum.https://groups.io/g/ucx](https://groups.io/g/ucx)

Revision History:

Rev.	Date	Features
[R1.02r]	2021-04-05	TX quality improvements, better robustness against RFI feedback, fix VOX issue,

Rev.	Date	Features
		single encoder/button-only control option, 16MHz Arduino Uno/Nano support, CW Messages.
R1.02n	2021-02-22	Key click reduction, TX bandwidth control, OLED fixes, CAT remote control features including RX audio streaming.
R1.02m	2021-01-27	CW support, TS480 CAT support, RX quality improvements, semi-QSK, PA PTT out with TX-delay, VFO-A/B/RIT, LPF switching, backlight saving, 160m.
R1.02j	2020-10-10	Integrated SDR receiver, CW decoder, DSP filters, AGC, NR, ATT, experimental modes CW, AM, FM, quick menu, persistent settings, improved SSB TX quality. LCD fix, selectable CW pitch.
R1.01d	2019-05-05	Q6 now digitally switched (remove C31) - improving stability and IMD. Improved signal processing, audio quality, increased bandwidth, cosmetic changes and reduced RF feedback, reduced s-meter RFI, S-meter readings, self-test on startup. Receiver I/Q calibration, (experimental) amplitude pre-distortion and calibration. (Original QCX-SSB mod is described here R1.01d)
R1.00	2019-01-29	Initial release of SSB transceiver prototype.

Schematic:

Below the schematic after the modification is applied, unused components are left out and changed components are marked in red (click to zoom & download) (link to [original schematic](#) <https://qrp-labs.com/images/qcx/HiRes.png>):

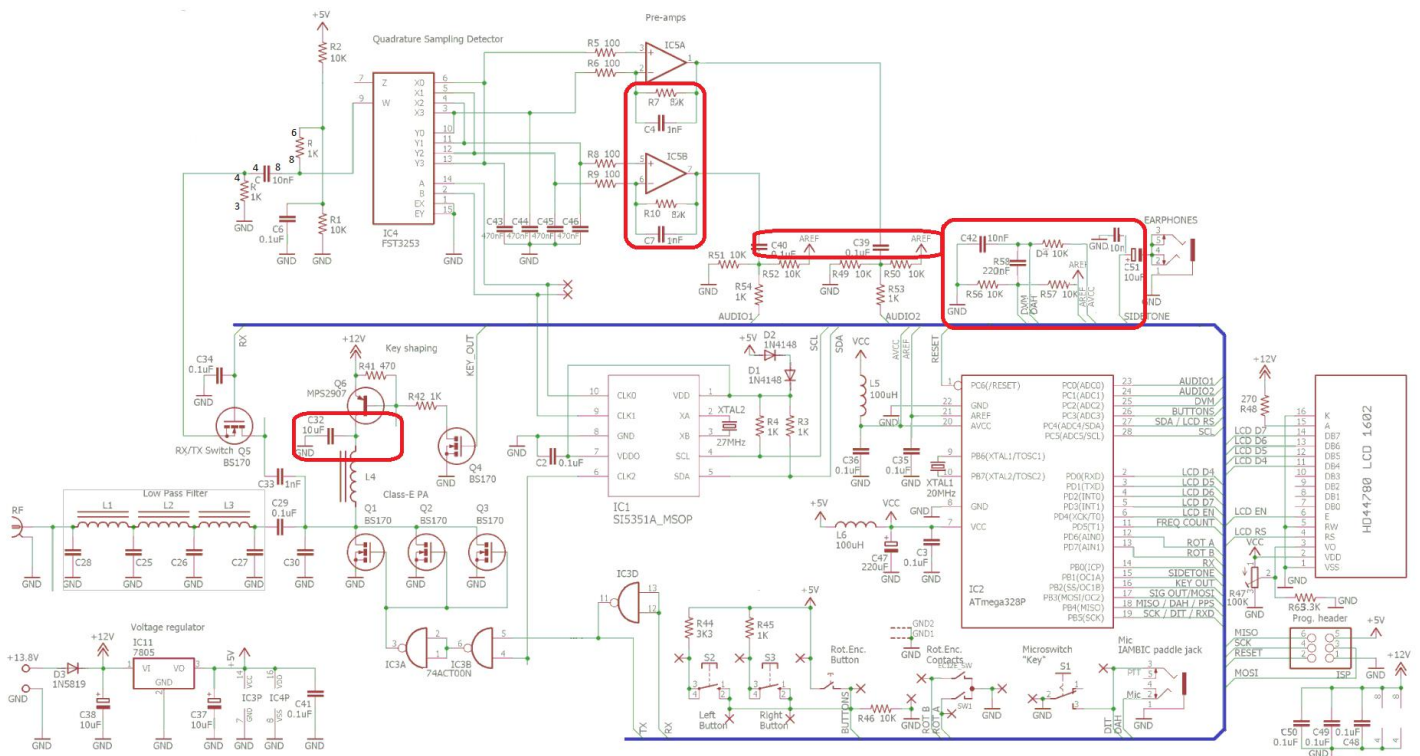

Operating Instructions:

Tuning can be done by turning the rotary encoder. Its step size can be decreased or increased by a short or long press. A change of band can be done with a double press. The mode of operation is altered with a short press on the right button; a double press on right button narrows the receiver filter bandwidth, the bandwidth is reset every time mode is changed. The volume is changed by turning the rotary encoder while pressed.

There is a menu available that can be accessed by a short left press. With the encoder it is possible to navigate through this menu. When you want to change a menu parameter, a press with left button allows you to change the parameter with the encoder. With the right button it is possible to exit the menu any time. A fast access to the menu and parameter can be achieved by pressing the left button while turning the encoder, once you lift the left button you can immediately change the parameter by turning the encoder.

For receive, by default an AGC is enabled. This increases the volume when there are weak signals and decreases for strong signals. This is good for SSB signals but can be annoying for CW operation. The AGC can be turned off in the menu, this makes the receiver less noisy but require more manual volume change. To further reduce the noise, a noise-reduction function can be enabled in the menu with the NR parameter. To use the available dynamic range optimally, you can attenuate incoming signal by enabling a front-end attenuator with "ATT" parameter. Especially on frequencies 3.5-7 MHz the atmospheric noise levels are much higher, so you can increase the receiver performance by adding attenuation (e.g 13dB) such that the noise-floor is still audible. To calibrate the transceiver frequency, you can tune to a calibrated signal source (e.g. WWV on 10 MHz) and zero-beat the signal by changing "Ref freq" parameter; alternatively you can measure the XTal frequency with a counter and set the parameter. A S-meter of choice (dBm, S, S-bar) can be selected with the S-meter parameter. Selecting an S-bar, shows a signal-strength bar where each tick represents a S-point (6dB).

For SSB voice operation, connect a microphone to the paddle jack, a PTT or onboard "key" press will bring the transceiver into transmit. With the "TX Drive" parameter, it is possible to set the modulation depth or PA drive, it is default set to 4 increasing it gives a bit more punch (compression for SSB). Setting it to a value 8 in SSB means that the SSB modulation is transmitted with a constant amplitude (possibly reducing RFI but at the cost of audio quality). To monitor your own modulation, you can temporarily increase MOX parameter. Setting menu item "VOX" to ON, enters the transceiver in Voice-On-Xmit operation (in TX mode as soon audio is detected), the VOX sensitivity can be configured in the menu with "VOX threshold" parameter. The PA Bias min and max parameters sets the working range of the PWM envelope signal, a range of 0-255 is the full range which is fine if you use a key-shaping circuit for envelope control, but when you directly bias the PA MOSFETs ([note 3](#)) with the PWM signal then you specify the optimal working range from just above the MOSFET threshold level to the maximum peak power you would like to use (0-180 are good values on my QCX).

For FT8 (and any other digital) operation, select one of the pre-programmed FT8 bands by double press the rotary encoder, connect the headphone jack to sound card microphone jack, sound card speaker jack to microphone jack, and give a long press on right button to enter VOX mode. Adjust the volume to a minimum and start your favorite FT8 application (JTDX for instance). The sensitivity of the VOX can be set in the "VOX threshold" parameter.

On startup, the transceiver is performing a self-test. It is checking the supply and bias voltages, I2C communications and algorithmic performance. In case of deviations, the display will report an error during startup. It also discovers the capabilities of the transceiver depending on the mods made. The following capabilities are detected and shown on the display: "QCX" for a QCX without mods; "QCX-SSB" for a QCX with SSB mod; "QCX-DSP" for a QCX with SIDETONE disconnected and connected to a speaker (through decoupling capacitor); "QCX-SDR" for a QCX with SDR mod. Please check if the this capability matches with the mods.

Technical Description:

The principle of operation (at least what is going on in the ATMEGA) is a bit as in the following video-fragment: [Opzij](#) (in Dutch saying; "Sideways, sideways, sideways, Make room, make room, make room, We are in an incredible rush"; full [lyrics](#)) here... :-) jokes aside; below the block diagram of the QCX-SSB, SDR transceiver:

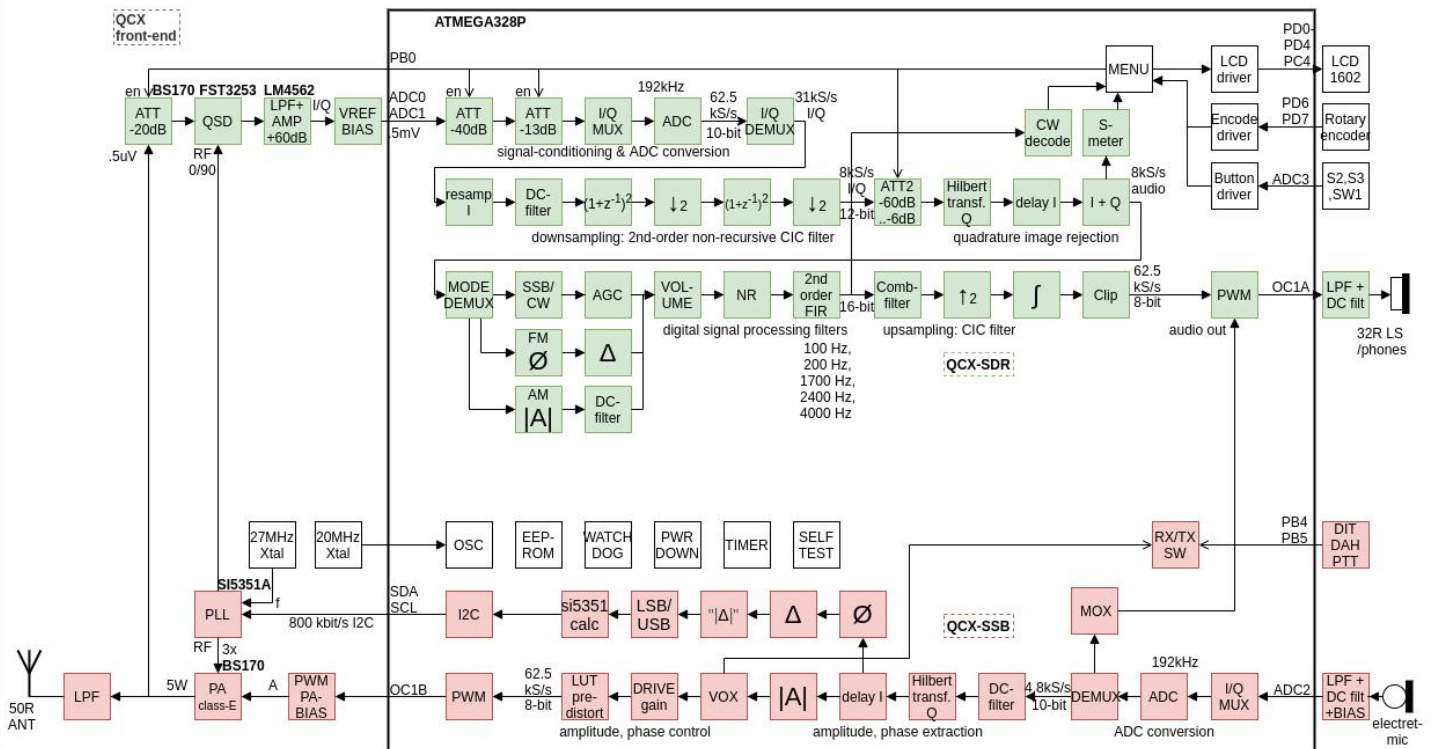

For SSB reception, the QCX analog phasing receiver stage is replaced with a digital SDR stage; this means that the phase shifting op-amp IC6 is changed into a regular amplifier and whereby the individual I and Q outputs are directly fed into the ATMEGA328P ADC inputs for signal processing. The ATMEGA328P (over-)samples the ADC input at a 62kHz sample-rate, and decimates this high-samplerate to a lower samplerate, performs a phase-shift by means of a Hilbert-transform, summing the result to obtain side-band rejection; it subsequently applies a low-pass filtering, AGC and noise-reduction functions. Since the original QCX phase-shifting network and analog CW filter are not used, about half of the original QCX components can be left out; by combining the function of IC7B into IC6A another op-amp can be saved. The ADC inputs are low-pass filtered (-40dB/decade roll-off at 1.5kHz cut-off) to prevent aliasing and input are biased with a 1.1V analog reference voltage to obtain additional sensitivity and dynamic range. With the 10-bit ADCs and a 4x over-sampling rate, a theoretical dynamic range of 72dB can be obtained in 2.4kHz SSB bandwidth. LSB/USB mode switching is done by changing the 90 degree phase shift on the CLK0/CLK1 signals of the SI5351 PLL. Three embedded attenuators are available for optimally using dynamic range; the first attenuator is the RX MOSFET switch Q5 responsible for 20dB attenuation, the second attenuator is ADC range (1.1V or 5V) selected by the ATMEGA ADC analog reference (AREF) logic and is responsible for 13dB attenuation, the third attenuator is a pull-down of an analog input on the ATMEGA with a GPIO port responsible for 53dB attenuation. Combining the three attenuators provides the attenuation steps 0dB, -13dB, -20dB, -33dB, -53dB, -60dB, -73dB.

For SSB transmission the QCX DVM-circuitry is changed and used as an audio-input circuit. An

electret-microphone (with PTT switch) is added to the Paddle jack connecting the DVM-circuitry, whereby the DOT input acts as the PTT and the DASH input acts as the audio-input. The electret microphone is biased with 5V through a 10K resistor. A 10nF blocking capacitor prevents RF leakage into the circuit. The audio is fed into ADC2 input of the ATMEGA328P microprocessor through a 220nF decoupling capacitor. The ADC2 input is biased at 0.55V via a divider network of 10K to a 1.1V analog reference voltage, with 10-bits ADC resolution this means the microphone-input sensitivity is about 1mV ($1.1V/1024$) which is just sufficient to process unamplified speech.

A new QCX-SSB firmware is uploaded to the ATMEGA328P, and facilitates a [digital SSB generation technique](#) in a completely software-based manner. A DSP algorithm samples the ADC2 audio-input at a rate of 4x4800 samples/s, performs a Hilbert transformation and determines the phase and amplitude of the complex-signal; the phase-changes are restricted [note 2](#) and transformed into either positive (for USB) or negative (for LSB) phase changes which in turn transformed into temporary frequency changes which are sent 4800 times per second over 800kbit/s I2C towards the SI5351 PLL. This result in phase changes on the SSB carrier signal and delivers a SSB-signal with a bandwidth of 2400 Hz whereby spurious in the opposite side-band components is attenuated. The amplitude of the complex-signal controls the supply-voltage of the PA, and thus the envelope of the SSB-signal. The key-shaping circuit is controlled with a 32kHz PWM signal, which can control the PA voltage from 0 to about 12V in 256 steps, providing a dynamic range of $(\log_2(256) * 6 =) 48\text{dB}$ in the SSB signal. C31 is removed to ensure that Q6 is operating as a digital switch, this improves the efficiency, thermal stability, linearity, dynamic range and response-time. Though the amplitude information is not mandatory to make a SSB signal intelligible, adding amplitude information improves quality. The complex-amplitude is also used in VOX-mode to determine when RX and TX transitions are supposed to be made. Instead of using a key-shaping circuit for envelope control, it is possible to directly bias the PA MOSFETs with the (filtered) PWM signal. This has the advantage of less losses and simplifies at the cost of linearity which result in more compression for an SSB signal (which is actually a good thing).

The IMD performance is related dependent on the quality of the system: the linearity (accuracy) of the amplitude and phase response and the precision (dynamic range) of these quantities. Especially the DSP bit-width, the precision used in the DSP algorithms, the PWM and key-shaping circuit that supplies the PA and the PA phase response are critical. Decreasing (or removing) C32 improves the IMD characteristics but at the cost of an increase of PWM products around the carrier.

Measurements:

The following performance measurements were made with QCX-SSB R1.01, a modified RTL-SDR, Spektrum-SVmod-v0.19, Sweex 5.0 USB Audio device and Audicity player. It is recognized that this measurement setup has its own limitations, hence the dynamic range of the measurements is somewhat limited by the RTL-SDR as this device goes easily into overload. Measurements were made with the following settings: USB modulation, no pre-distortion, two-tone input 1000Hz/1200Hz where audio level is set just before the point where compression starts. Results:

Intermodulation distortion products (two-tone; SSB with varying envelope) IMD3, IMD5, IMD7: respectively -33dBc; -36dBc; -39dBc

Intermodulation distortion products (two-tone; SSB with constant envelope) IMD3, IMD5, IMD7: respectively -16dBc; -16dBc; -19dBc

Opposite side-band rejection (two-tone): better than -45dBc

Carrier rejection (two-tone): better than -45dBc

Wide-band spurious (two-tone): better than -45dBc

3dB bandwidth (sweep): 0..2400Hz

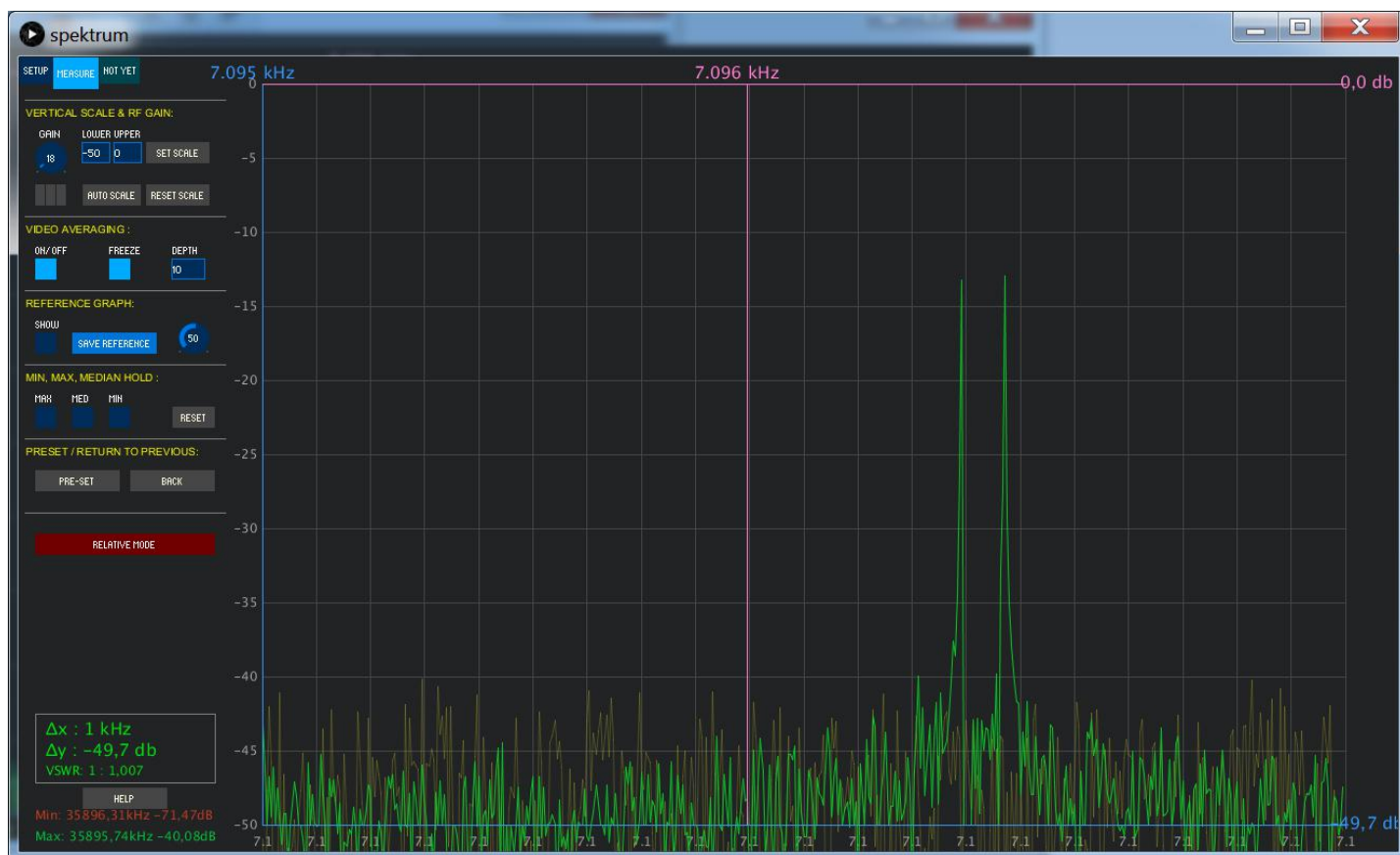

Credits:

[QCX](#) (QRP Labs CW Xcvr) is a kit designed by Hans Summers (G0UPL), originally built for RSGB's YOTA summer camp 2017, a high performance, image rejecting DC transceiver; basically a simplified implementation of the [NorCal 2030](#) by Dan Tayloe (N7VE) designed in 2004 combined with a [Hi-Per-Mite](#) Active Audio CW Filter by David Cripe (NMØS), [Low Pass Filters](#) from Ed (W3NQN) 1983 Articles, a key-shaping circuit by Donald Huff (W6JL), a BS170 switched [CMOS driven MOSFET PA](#) architecture as used in the [ATS](#) designs by Steven Weber (KD1JV) (originating from the [Power MOSFET revolution](#) in the mid 70s), a [Ghetto-class-E](#) filter-network published by Paul Harden (NA5N) and an Atmel [ATMEGA328P](#) microprocessor, a Hitachi [HD44780](#) LCD display and a Silicon Labs [SI5351](#) Clock Generator (and using a [phase shift in the SI5351 clocks](#)). The [QCX-SSB](#) transmitter and QCX-SDR receiver stage both running on a ATMEGA328P, including its multiband front-end and direct PA biasing/envelope-generation technique; its concept, circuit, code and modification to run on a QCX are a design by Guido (PE1NNZ); the software-based SSB transmit stage is a derivate of earlier experiments with a [digital SSB generation technique](#) on a Raspberry Pi. The assembly manual for the QCX Rev 5 PCB, is the work of Manuel (DL2MAN). Many thanks to all of you who got interested in this project and took the challenge and effort to try out QCX-SSB. Without your valuable feedback and contributions the project could not have kept moving on, improving and challenging new ideas!